

MODEL 539

MAGNETOMETER SENSOR

FEATURES

- High speed digital 3-axis magnetometer
- Up to 38400 baud transmission rate
- Simplified magnetic data acquisition
- Use in command mode or autosend mode
- -25°C to 70°C operating temperature range

APPLICATIONS

- High speed magnetic sensing
- Magnetic anomaly detection
- Guidance/Compassing
- Laboratory measurements
- Materials testing

The Model 539 was the first high-speed digital output 3-axis fluxgate magnetometer to be commercially available. The system can convert and transmit over its serial port (at 38400 baud) to all three axes outputs at a rate of 250 samples per second. Slower data rates can also be selected; transmission rate and baud rates are user programmable.

The Model 539 uses three separate 16-bit sigma delta converters to achieve the high throughput. The scale factor is set so that a full scale input of $\pm 10^{-4}T$ (1G) represents 32768 counts on the system Analog-to-Digitals. The least count represents about 3nT. Noise of the system is 1 - 2 counts.

The Model 539 can be used in either a command mode or autosend mode. In the command mode, the Model 539 responds



to commands to transmit data issued by an external computer. In the autosend mode, the Model 539 begins sending data as soon as power is applied to the unit.

The Model 539 can be supplied with an optional connection cable and breakout box which allows easy powering and connection to an external computer. A Windows-compatible configuration, data acquisition, and display program is supplied with the 539. This program enables the user to acquire and graphically display data as well as configure the Model 539 send rate, baud rate, output format, and other features.

In addition to the standard RS232 interface, the Model 539 is also equipped with a TTL interface for communication with a microprocessor.

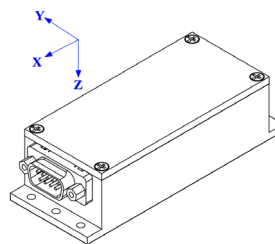
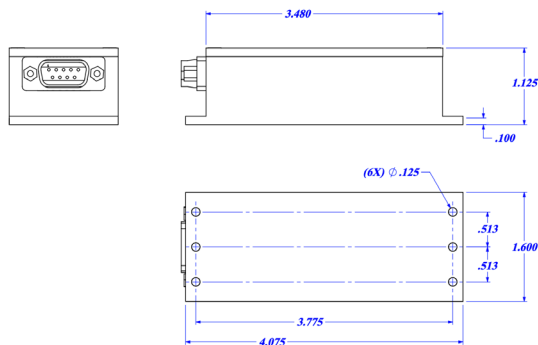

PIN	FUNCTION
2	RS232 OUT
3	RS232 IN
5	Ground
9	+Voltage In
1,4,6,7,8	Reserved- must be floating

ELECTRICAL

Input Voltage Range	+4.95 to +9 VDC
Current Draw	<80mA at 8VDC
Digital Output Protocols	RS232 and TTL
Digital Output Formats	ASCII and Binary
Baud Rate	User Programmable up to 38400 baud
Maximum data transfer speed (38.4k baud)	250 3-axis samples/sec
Analog to Digital	16-bit Sigma Delta

ENVIRONMENTAL

Operating Temperature Range	-25°C to +70°C
Storage Temperature Range	-55°C to +160°C

PERFORMANCE

Range	$\pm 6.5 \times 10^4$ nT (± 0.65 G) ± 100 μ T (± 1 G) optional
Resolution	2 nT (20 μ G)
Accuracy	± 1 % Full Scale
Linearity	± 0.1 % Full Scale
Initial Offset	$< \pm 200$ nT (± 2 mG)
Offset vs. Temperature	< 5 nT/°C (< 0.05 mG)
Scale Stability	0.05% Full Scale/°C
Noise Level	0.3 nT (3 μ G) RMS/ $\sqrt{\text{Hz}}$
Frequency Response	DC to 400 Hz (-3 db)
Orthogonality of Axes	Better than $\pm 0.5^\circ$
Alignment of Axes with Package	Better than $\pm 0.5^\circ$

PHYSICAL

Width	1.6" (40.64 mm)
Height	1.125" (28.575 mm)
Length	4.08" (103.632 mm)
Weight	150 g
Input Connection	9-pin nonmagnetic "D" (Female)

Specifications are subject to change without notice.